

GLIDELINE

GR49 RESIDENTIAL DOOR



SPECIFICATION



CONFIGURATIONS

SINGLE, FRENCH, SIDELIGHTS, TOP LIGHTS

SIGHTLINES

49MM SASH

GLAZING

MAX. 48 MM, MIN. 25 MM

MAXIMUM SASH DIMENSIONS

WIDTH (L) 1200 MM, HEIGHT (H) 3000 MM

MAXIMUM SASH WEIGHT

120 KG

COLOUR

POWDER COATING RAL FINISH
STANDARD 7016M, 9005M, 9016G
AVAILABLE IN 150+ RAL FINISHES
TEXTURED FINISH AVAILABLE
SPLIT COLOR FOR INTERIOR/EXTERIOR
WOOD EFFECT POWDER COATING
ANODIZED ALUMINIUM

BFRC Rating

kWh/(m²·yr)

≥20	A ++
>10 to 20	A +
0 to <10	A ✓
-10 to <0	B
-20 to <-10	C
-30 to <-20	D
-50 to <-30	E

FEATURES

Transmittance		Uw ≥ 0.8 (W/m ² K)
Acoustic insulation		Rw up to 41 dB
Air permeability		Class 4
Water tightness		Class E750
Wind resistance		Class C3

PAS24

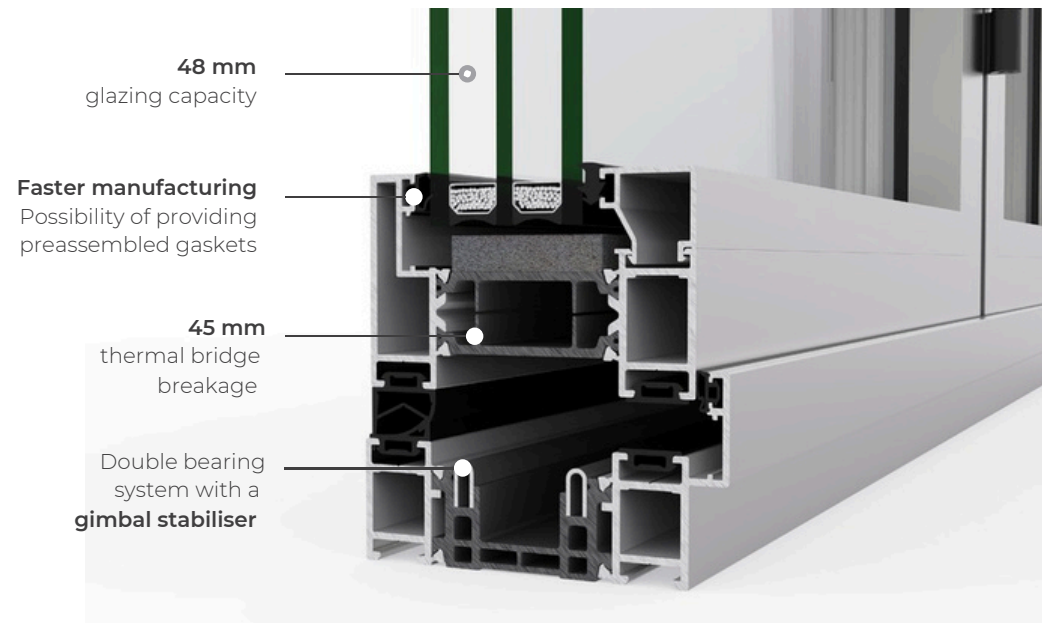

ARTBURY 3



ABER 5



ASPEN 1



ARAMON 3



AUTRANS 2



AROLLA 4



AVORIAZ 1



AROLLA 5



CARONA 2



AVORIAZ 1 LITE



CERVINIO 1



BERNEX 2



COLOGNE 4



BERNEX 3



COURCHEVEL 3



BORMIO 3



JAVORNIK 3



ELORN 1



LB 6



FALERA 3



LEYSIN 3



FUJI 1



LURISIA 4



IGMAN



LUZERN 3

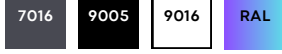

MANALI 6



MASELLA 5



MATIGNY 2

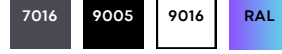

MERIZINE 3



MOLVINIO 1



MOLVINIO 3



MORZINE 1



NEOSLOPE 3



NEVIS 1



NEVIS 3



NEVIS 4



NEVIS 5



OLYMPUS 4



PECA 3



PILLIO 1



PORTE 1

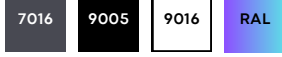

SHIPLAP

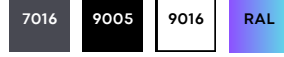

SMOOTH SOLID

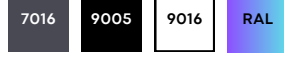

SOVATA 6

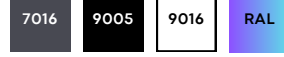

SUMMIT 6



TAVASCAN 2

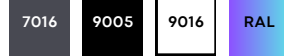

TRIBERG 1



USTRON



VEYSONNAZ 3



UZANA 2



VEYSONNAZ 5



UZANA 3



VIDRA 4



VALNORD 2



ZERMATT 3



VERBIER 3



HARDWARE

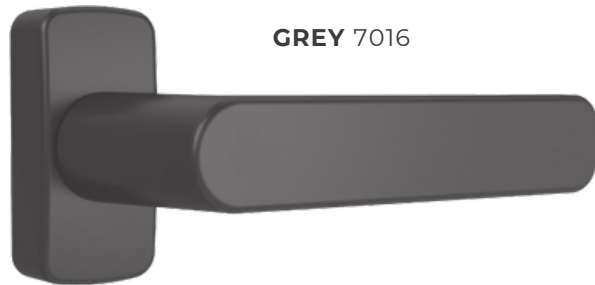

GREY 7016

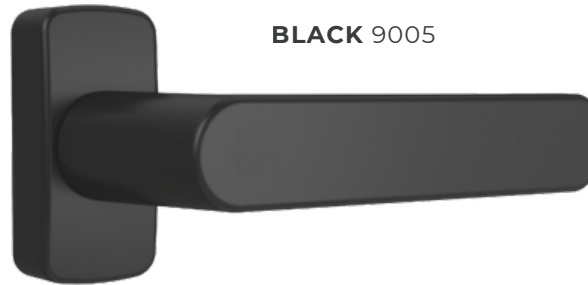

BLACK 9005



WHITE 9016



CUSTOM RAL



BAR HANDLE

Regardless of whether you're looking to maintain modern aesthetics or a more traditional style, our choice of colours will suit you. We have a range of handle options to choose from to achieve the perfect look.

The GR49 has been carefully designed to be thermally efficient. With a U-value of $1.0 \text{ W/m}^2\text{K}$, your or your customer's home will be comfortable all year round.



GLIDELINE